

Transcutaneous Electrostimulation Unit

Operating Manual

DiaDENS • Osteo

Россия/ Russia	<input type="checkbox"/>
ЕС, все страны/ EU, all	<input checked="" type="checkbox"/>
США/ USA	<input type="checkbox"/>
Канада/ Canada	<input type="checkbox"/>

RC ART-08.0-03.72-01 RE

CONTENTS

Part 1. Technical Passport

1. Safety Rules.....	6
2. Intended purpose.....	9
3. Technical description.....	10
4. Scope of supply.....	16
5. Unit structure.....	17
6. Operation.....	21
7. Maintenance.....	24
8. Battery replacement procedure.....	25
9. Troubleshooting.....	26
10. Manufacturer's guarantees.....	28

Part 2. Application Instructions

1. General.....	30
2. Intended purpose.....	32
3. Indications and Contraindications.....	33
4. Treatment conditions.....	34
5. Electrostimulation intensity.....	35
6. Application Recommendations.....	37
Warranty Maintenance Form.....	41
Acceptance certificate.....	44

This is the Operating Manual for DiaDENS-Osteo electrostimulation unit with integrated electrodes designed for the stimulation of the reflexogenous areas on the posterior surface of the neck of humans.

This Operating Manual includes the Technical Passport (Part 1) and the Application Instructions (Part 2).



Compliance:

This medical device bears the CE marking in compliance with Directive 93/42/EEC concerning Medical Devices

A series of 15 horizontal dashed lines for writing.

PART 1

Technical Passport

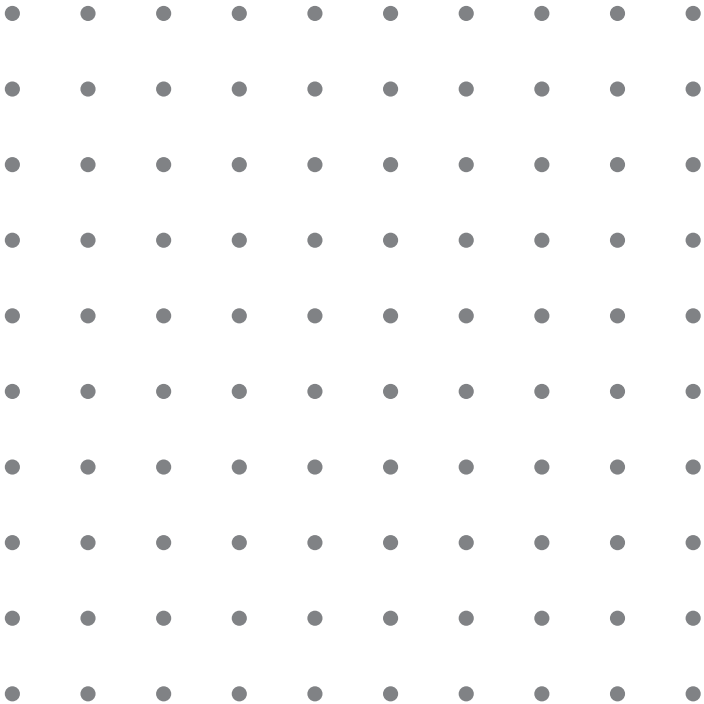

1. SAFETY RULES



The information contained in this Operating Manual is important for your safety and for correct application and maintenance of the unit.



The unit is safe in service as it uses the low voltage power supply isolated from the working part of the unit (type B device with a type F working part).



The unit may not be used to treat patients with implanted electronic devices (such as the heart pacemaker) and to treat patients with idiosyncrasy to electric current.



The unit may not be used in the area of direct projection of the heart at the front.



During stimulation the patient should not be connected to any high frequency electric device. Simultaneous use of the unit and other electric devices may cause burns and possible damage of the unit.



Operation in the vicinity of short-wave or microwave equipment may cause the output parameters of the unit to become unstable.



Avoid long-term exposure of the unit to direct sunrays at a high ambient temperature (over 25 °C). This may cause failure of the indicator on the unit or destroy its batteries.



The unit contains fragile components. Make sure it is shock-protected.



The unit is not watertight. Protect it from penetration of moisture.



All maintenance works on the unit must be performed by skilled technicians at the manufacturing factory.

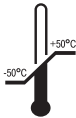

Transportation conditions: temperature -50 to +50 °C, relative air humidity 30 to 93 %, atmospheric pressure 70 to 106 kPa.

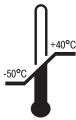

Storage conditions: temperature -50 to +40 °C, relative air humidity 30 to 93 %, atmospheric pressure 70 to 106 kPa.

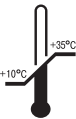

Operating conditions: temperature +10 to +35 °C, relative air humidity 30 to 93 %, atmospheric pressure 70 to 106 kPa.



If the unit was stored at the ambient temperature lower than 10 °C, before operating keep it under normal climatic conditions for at least two hours.



Recycling: the unit packaging materials do not have a harmful effect on the environment; they can be recycled.



Separate collection of electric and electronic equipment.

The unit contains precious materials that may be used repeatedly after disposal with consideration of the environmental protection regulations.

They must be submitted to specially designated collection and recycling facilities (please consult in the relevant services in your locality).



Warning: no modification of this equipment is allowed.

2. INTENDED PURPOSE



DiaDENS-Osteo Unit is used for stimulation of reflexogenous areas on the posterior surface of the neck of humans. The unit is equipped with integrated electrodes.

DiaDENS-Osteo is designed for individual application at medical and preventive treatment facilities and at home in accordance with the indications of the attending physician.

The unit may be used for treating patients older than 14 years of age.

The unit is designed for correction of functional disorders that develop due to pathologies that involve the cervical spine, muscles of the neck and the shoulder girdle.

3. TECHNICAL DESCRIPTION

3.1. The impulse has the following output parameters at the rated supply voltage:

3.1.1. Duration of the positive phase of the impulse with the minimum signal power under the load of 2 kOhm is $25 \pm 10 \mu\text{s}$.

In its positive phase the impulse has the range of up to 30 V.

In its negative phase the impulse has the range of up to 30 V.

3.1.2. Duration of the positive phase of the impulse with the maximum signal power under the load of 2 kOhm is $250 \pm 70 \mu\text{s}$.

In its positive phase the impulse has the range of $30 \pm 10 \text{ V}$.

In its negative phase under load ($20 \pm 1 \text{ kOhm}$) the impulse has the range of $150 \pm 70 \text{ V}$.

3.1.3. The stimulation range at the minimum power level is $\approx 50 \%$ of the range at the maximum power level ($R = 20 \text{ kOhm}$).

3.2. Relation of the impulse shape to the load resistance at the medium and maximum power level.

Table 1



Load resistance	Power level 7		Power level 15	
	Voltage waveform	V p-p	Voltage waveform	V p-p
No load		$\approx 140 \text{ V} \pm 20 \%$		$\approx 140 \text{ V} \pm 20 \%$
200 Ohm		$\approx 9 \text{ V} \pm 20 \%$		$\approx 10 \text{ V} \pm 20 \%$
500 Ohm		$\approx 24 \text{ V} \pm 20 \%$ leff $\approx 16 \text{ mA}$ Epulse $\approx 42 \mu\text{s}$		$\approx 28 \text{ V} \pm 20 \%$ leff $\approx 8 \text{ mA}$ Epulse $\approx 78 \mu\text{s}$
1 kOhm		$\approx 42 \text{ V} \pm 20 \%$		$\approx 54 \text{ V} \pm 20 \%$

Load resistance	Power level 7		Power level 15	
	Voltage waveform	V p-p	Voltage waveform	V p-p
2 kOhm		≈ 60 V \pm 20 %		≈ 84 V \pm 20 %
10 kOhm		≈ 140 V \pm 20 %		≈ 140 V \pm 20 %
20 kOhm		≈ 140 V \pm 20 %		≈ 140 V \pm 20 %

3.3. The unit can operate in two selectable modes – Relaxation and Pain Therapy. They have different duration of stimulation (15 and 20 minutes respectively) and use different type of stimulation of reflexogenous zones.

Each mode incorporates 3 stimulation phases with the parameters shown in Table 2.

	Pain Therapy mode			Relaxation mode		
	Phase 1	Phase 2	Phase 3	Phase 1	Phase 2	Phase 3
Signal frequency, Hz	125±25	20±4	7710*	125±25	20±4	7710*
Duration of stimulation, min	5±0,5	5±0,5	10±1,0	5±0,5	5±0,5	5±0,5

3.4. The maximum consumption current (at the supply voltage 3 V) of the electrostimulation unit does not exceed 140 mA.

3.5. Power supply source: 2 LR6/AA type batteries with the total voltage of $3,0\pm 0,6$ V. The unit can use rechargeable batteries of respective type, dimensions and voltage**.

3.6. Weight of the key components of the electrostimulation unit:

- remote control — not more than 80 g;
- a neck electrode unit — not more than 170 g.

3.7. Dimensions of the key components of the electrostimulation unit:

- remote control — not more than 30x50x22 mm;
- a neck electrode unit — not more than 120x60x40 mm.

* 77 ± 20 Hz and 10 ± 3 Hz frequency interleaving in bursts of 0.25 ± 0.05 s

** *The operating procedure (types of chargers and charging methods) is described in the operating manual supplied with the batteries. The unit operation duration with rechargeable batteries depends on the properties of the batteries.*

3.8. The unit will shut down 2 minutes after any of the buttons was pressed last (except for the ON/OFF button) or after the last application of the electrodes to the patient's skin surface.

3.9. Electromagnetic radiation.

Table 3

Test	Conformity	Conditions of use
HF radiation CISPR 11	Class B	DiaDENS-Osteo can be used in all kinds of facilities, including application at home

3.10. HF radiation resistance

Table 4

Test	IEC 60601-1-2 testing conditions	Acceptable level
IEC 61000-4-6	3 Vrms 150 kHz to 80 MHz	3 Vrms
IEC 61000-4-3	3 V/m 80 MHz to 2,5 GHz	3 V/m

3.11. Electromagnetic field resistance.

Table 5

Test	Test level	Conformity level	Conditions of use
Electrostatic discharge (ESD) IEC 61000-4-2	± 6 kV contact ± 8 kV air	± 4 kB contact ± 8 kB air	The floor should be made of wood, concrete or ceramic tiles. If the floor is covered with synthetic materials, relative air humidity should be at least 40 %
Magnetic fields IEC 61000-4-8	3 A/m	3 A/m	The magnetic field parameters should not exceed the limits for commercial buildings and medical facilities

3.12. Recommendations concerning determination of the required distance between the DiaDENS-Osteo electrostimulation unit and radio frequency radiating equipment.

Table 6

Declared maximum output power of the transmitter P (W)	Radiation frequency and the distance d determination formula (m)		
	150 kHz — 80 MHz $d = 1,2\sqrt{P}$	150 kHz — 800 MHz $d = 1,2\sqrt{P}$	800 MHz — 2,5 GHz $d = 2,3\sqrt{P}$
0,01	0,12	0,12	0,23
0,1	0,38	0,38	0,73
1	1,2	1,2	2,3
10	3,8	3,8	7,3
100	12	12	23

4. SCOPE OF SUPPLY

The scope of supply of DiaDENS-Osteo should be as specified in Table 7

Table 7

Name of product, component part, document	Number
Control unit	1
Neck electrode unit	1
Operating manual	1
Consumer package	1
Battery (type AA)	2

5. UNIT STRUCTURE

5.1. General Information

The DiaDENS-Osteo unit comprises a neck electrode unit and a control unit connected with each other via a cable. The batteries are installed into the special compartment in the neck electrode unit.

5.2. The neck electrode unit

The neck electrode unit (picture 1) is fixed to the

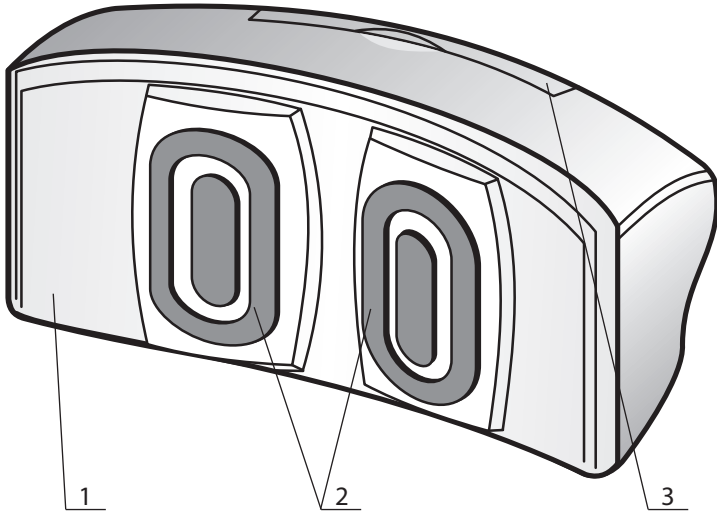

Picture 1. External view of the neck electrode unit

1. Body
2. Integrated electrodes
3. Battery compartment cover

posterior surface of the patient's neck by means of soft elastic strapping. The neck electrode unit provides direct stimulation of the reflexogenous zones on the posterior surface of the patient's neck.



Before using the device, the patient should take off from his/her neck all conducting jewelry (metal chains etc.).



Do not connect anything except the control unit supplied with DiaDENS-Osteo to the neck electrode unit. Connection of a device that is not designed for use with the unit may cause failure of the unit or failure of the neck electrode unit and can also be harmful for the user. Failure of the neck electrode unit due to connection of a device that is not designed for use with the unit is not covered by the warranty!



Patients may develop allergic reactions due to idiosyncrasy to the materials used in the unit. If an allergic reaction develops, the patient should stop using the unit and consult a physician.

5.3. Control unit



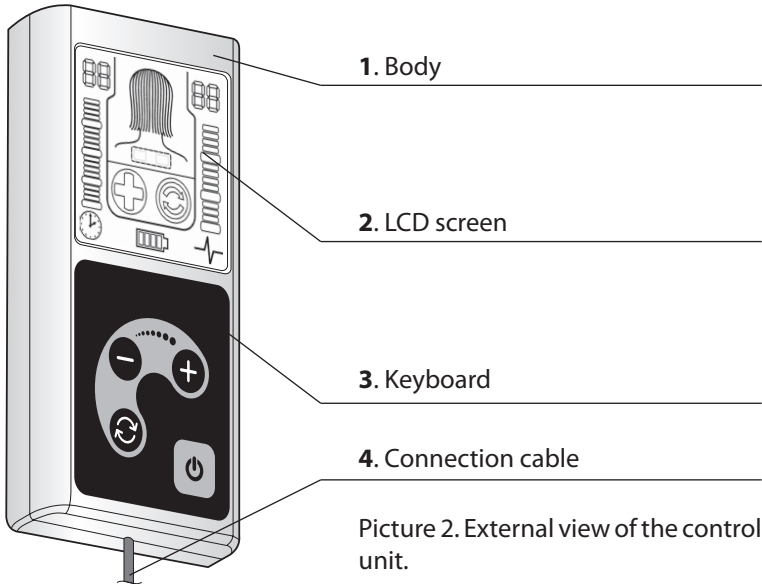

The control unit (picture 2) controls the electrostimulation modes and power in the neck electrode unit.



Do not connect the control unit to anything except the neck electrode unit supplied with DiaDENS-Osteo. Connection of the control unit to a device that is not designed for use with the unit may cause failure of the unit or failure of the control unit. Failure of the control unit due to connection of a device that is not designed for use with the unit is not covered by the warranty!

5.3.1. Control buttons on the keyboard

Table 8

Control buttons*			
			
Unit ON/OFF	Electrostimulation mode selection	Stimulation power down	Stimulation power up

5.3.2. Control unit screen

1. Therapeutic signal duration digital screen and scale

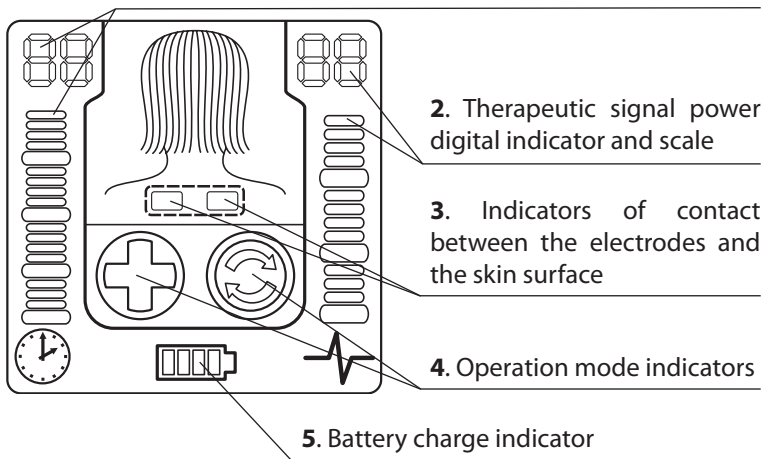

* When any of the buttons on the keyboard is pressed, the indicator flashes on and remains illuminated for a short period of time.

6. OPERATION

6.1. Preparation of the unit for operation

Open the battery compartment cover on the neck electrode unit (NEU). Install the batteries as described in Paragraph 8 of this Technical Passport. Replace the battery compartment cover.

Connect the control unit (CU) to the NEU.

Fix the NEU to the posterior surface of your neck without or with external help, making sure that the electrode are in close contact with your neck but the strapping is not too tight. In order to achieve a better contact you can wipe your skin in the area exposed to the electrodes with a wet cotton wool wad or apply a small amount of Malavtilin cream (stimulation can be started after your skin completely absorbs the cream).

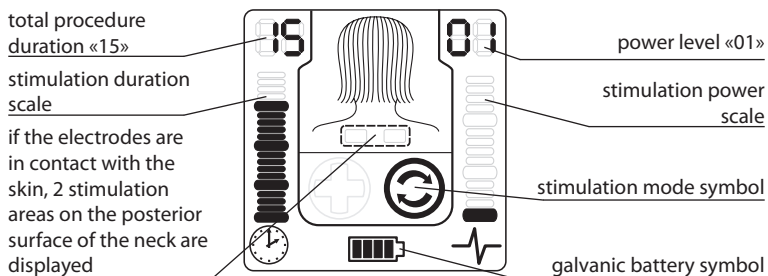

6.2. Starting the unit

Press the  button on the control unit for a short time; you should hear the greeting tune and see the following information on the screen:



6.3. Operation of the unit

6.3.1. Press the  button for a short period of time to change the mode.

To set or change the electrostimulation power, use the  and  buttons.



Power increase is controlled subjectively, depending on the patient's sensations as the electrodes touch the skin surface. The power should not exceed the pain threshold.

As soon as the power is higher than zero and all electrodes are in contact with the skin surface, the unit will switch to the electrostimulation mode in accordance with the selected mode and power level.

If during therapy even one electrode loses contact with the skin surface, the unit provides an alarm signal corresponding to the event and the procedure is stopped for 3 seconds. If the contact with the skin surface is restored after this period, the procedure continues; if the contact is not restored, the unit switches to the standby mode.

The stimulating electric signal power can be changed in the process of therapy; in this case the process is not stopped and does not restart.



The procedure stops automatically upon expiration of the procedure time set for the mode being used. After the procedure stops, the actual electrostimulation

power drops to the minimum, but the screen continues to show the power level set before.

The stimulation procedure can be repeated by changing the mode (pressing the  button once or twice), or by breaking the contact of the electrodes with the patient's skin for a short time and then restoring it, or by changing the stimulation power.

For forced termination of the therapy mode either decrease the stimulation power to zero or remove the neck electrode unit from the patient's neck.

6.4. Switching off the unit

In order to switch off the unit, press the  button and hold it for a long time (more than 3 seconds) until the unit sounds the tune designating the end of the procedure. After that you can release the  button and the unit will switch off as soon as the tune ends.

The unit normally switches off automatically if it is not used for 2 minutes. It is understood that the unit is not used if the electrodes are not in contact with the skin surface and none of the buttons is pressed.

7. MAINTENANCE

7.1. Daily maintenance should include the following operations:

- external inspection of the unit;
- disinfection of the electrodes.

To clean the electrodes, use standard disinfectants (such as 70% alcohol solution) and soft pile-free tissues.

7.2. If the unit will not be used for a long period of time (more than 3 days), remove the batteries from the battery compartment in the NEU.

7.3. If the battery indicator flashes, replace the batteries.

8. BATTERY REPLACEMENT PROCEDURE

Battery replacement:

- open the battery compartment;
- remove the batteries;
- keep the unit without the batteries for at least 2 minutes;
- install the new batteries *, respecting the polarity.

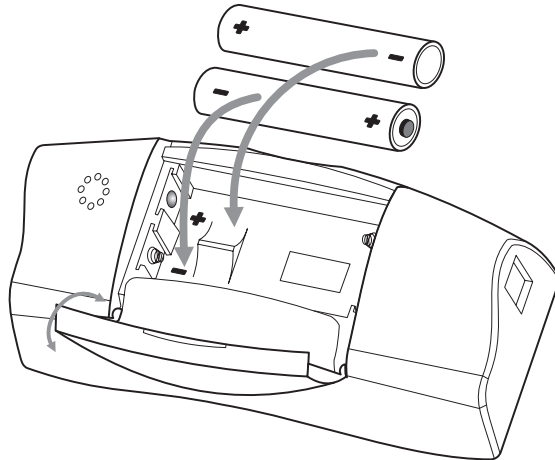

* *Install only the batteries intended for this unit – type LR6/AA, with rated voltage 1.5 V or rechargeable batteries designed for the unit with the rated voltage 1.2 V. Remove the batteries from the unit if you plan not to use it for a long time.*

9. TROUBLESHOOTING

Possible defects and methods of their correction are shown in Table 9.

Table 9

Defect	Possible cause	Method of correction
The unit does not turn on when you press the ON/OFF button	Batteries are not installed	Install new batteries (see Battery Replacement Procedure)
	Wrong polarity was chosen when installing batteries into the battery compartment	Make sure you choose correct polarity; if necessary, install batteries as marked on the unit
	Battery voltage less than 2.2 V	Replace batteries (see Battery Replacement Procedure)
When the unit is turned on, alarm sounds and the unit switches off automatically	Battery voltage less than 2.2 V	Replace batteries (see Battery Replacement Procedure)
Unit does not switch to Therapy mode	Poor contact of electrodes with skin surface	Make sure that the electrodes are in good contact with the surface. If necessary, wet the skin surface in the area where the electrodes touch it before the procedure

Defect	Possible cause	Method of correction
The unit does not switch off automatically when there is no contact between the electrodes and the skin surface and when its controls have not been used for more than 2 minutes	Current leakage on the therapeutic electrodes of the unit	Clean the therapeutic electrodes and wipe them with alcohol or an alcohol-containing liquid
The unit switches off automatically during operation	Battery voltage less than 2.2 V	Replace batteries (see Battery Replacement Procedure)
	Poor cable contact in the connector of the neck electrode unit	Make sure that the control unit is connected to the neck electrode unit
"Quick consumption" of batteries	Poor quality batteries	Use good quality batteries (alkaline batteries are recommended) or rechargeable batteries of the corresponding type and size with the voltage not exceeding 1.5 V

10. MANUFACTURER'S GUARANTEES

10.1. Lifetime of the unit — 5 years.

If the operating instructions are followed, the lifetime may be much longer than the officially established one.

10.2. Warranty operation term — 24 months of the date of sale.

10.3. The warranty does not cover the units with destroyed factory seals.

10.4. In case of failure of the unit or its defect during the effective term of the warranty and if the owner discovers that certain components are missing, the owner of the unit shall send to the manufacturer or his representative a repair (replacement) request stating his full name, address and telephone number and containing a short description of the defect and the conditions in which and the date when it was discovered.

Manufacturer's address:

LLC "RC ART", 620146 Russia

Ekaterinburg, Akademika Postovskogo Str., 15

Phone: +7 (343) 267-23-30,

<http://www.denascorp.ru>, e-mail: corp@denascorp.ru

Official Representative in the European Union:

DENAS-CZ s.r.o.,

Na Vyhlade 3a, 36017, Karlovy Vary, Czech Republik

PART 2

Application Instructions

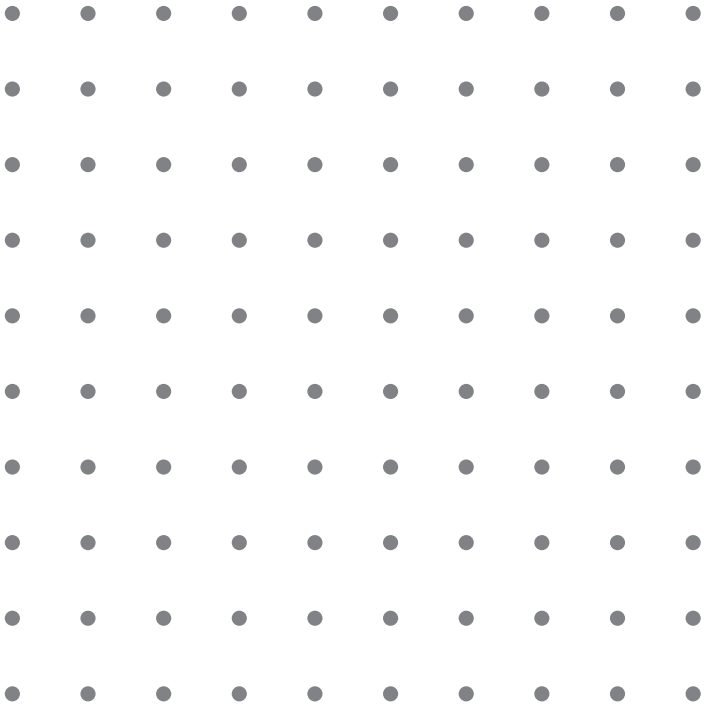

1. GENERAL

The neck is the most mobile and vulnerable part of the spine; that is everyone has experienced neck pain at least once in his life, irrespective of the age and the gender. Pain is most often caused by diseases and injuries of the cervical spine, the muscles and ligaments in the neck.

The first cervical vertebra is called the atlas. According to ancient Greek myths, Atlas is a Titan who is holding the heavens on his shoulders.

The neck supports the head, and the perfusion of the brain and general condition of the body is directly dependent on the condition of the cervical spine. That is why neck pain requires special attention and care.

More and more often non-medication acute and chronic pain treatment is becoming the method of choice for physicians and patients.

No matter what the cause for neck pain may be, effective treatment and prevention of acute conditions involves a competent integrated approach that includes dynamic electric neurostimulation (DENS) as its important part.

Numerous studies show that the therapeutic effect of DENS is based on 33 multi-level reflex and neurochemical reactions triggering a cascade of regulatory and adjustment mechanisms of the body.

The procedure eliminates pain syndromes, improves blood circulation, activates production of biologically active substances and tissue metabolism and normalizes muscular and vascular tonus.

Due to dynamic electric neurostimulation promotes wellness, good spirits and general fitness.

2. INTENDED PURPOSE

DiaDENS-Osteo unit is used for treating humans by means of electrostimulation of reflexogenous zones in on the posterior surface of the neck. The unit is equipped with integrated electrodes.

DiaDENS-Osteo unit is intended for individual application in medical and preventive treatment facilities and at home as indicated by the attending physician.

DiaDENS-Osteo is designed for individual application at medical and preventive treatment facilities and at home in accordance with the indications of the attending physician.

The unit may be used for treating patients older than 14 years of age.

The unit is designed for correction of functional disorders caused by pathologies that involve the cervical spine, muscles of the neck and the shoulder girdle.

3. INDICATIONS AND CONTRAINDICATIONS

3.1. Indications

Pain syndrome, muscle tension, limited mobility, muscle fatigue and other functional disorders caused by diseases of the cervical spine, the neck muscles and the shoulder girdle and long-term forced position or hard physical work.

3.2. Contraindications:

- idiosyncrasy to electric current;
- an implanted heart pacesetter;
- status epilepticus;
- neoplasia with any etiology and localization;
- acute fever with unknown etiology;
- venous thrombosis;
- acute mental, alcoholic or narcotic excitement.



If you have any of the above listed contraindications, consult your physician before using this device.



In case of idiosyncrasy, if you feel worse or the pain increases during the procedure, stop the stimulation and consult a physician immediately.

4. TREATMENT CONDITIONS

No special conditions are required for this procedure. The procedures can be performed without attendance of a physician or a nurse. During the procedure, the patient may be seated in an armchair or may lie in a comfortable position.

It is recommended to take a 10–15 minute rest after the procedure.



After each procedure clean the electrodes with a standard disinfectant solution (such as 70% alcohol solution). The unit should be stored with dry electrodes.

5. ELECTROSTIMULATION INTENSITY

Electrostimulation intensity (power) is determined individually depending on the patient's individual sensations. For convenience electrostimulation power is divided into three levels (power ranges).

The first, or minimum, level — the patient does not have any subjective sensations or feels a slight vibration in the area under the electrodes.

This level is used when intensive stimulation is not recommended, that is for patients with cardiovascular diseases (arterial hypertension, arterial hypotension and vegeto-vascular dystonia syndrome).

The minimum power level is also indicated for the treatment of patients suffering from frequent headaches and vertigo.

The second, or comfortable, level — the patient feels vibration, pleasant tingling or a slight “burning” but without any painful sensations.

This level is used for the treatment of patients complaining of slight and medium intensity pain. This is the most frequently used power level.

The third, or maximum level — the patient has a painful tingling or burning sensation.

Stimulation of such intensity may be accompanied by involuntary contraction of muscles located close to the electrodes.

This level is used for the treatment of a strong pain syndrome.



At different stages of treatment the electrostimulation power level can be increased and decreased as the patient's individual tolerance changes and as the pain decreases.



The power level should be adjusted depending on the patient's sensations. Do not exceed the pain threshold.

6. APPLICATION RECOMMENDATIONS





It is recommended to set only the minimum power level (5 units) for treating patients with cardiovascular diseases (arterial hypertension, arterial hypotension and vegeto-vascular dystonia syndrome) and patients suffering from frequent headaches.

6.1. — Program A (pain therapy).

The program is applied when the patient's main complaint is strong pain in the neck or the shoulder girdle.

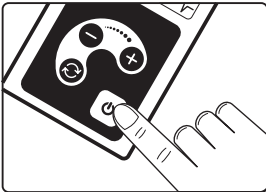
To perform the procedure:



1. Switch on the unit by pressing the  button on the control unit.

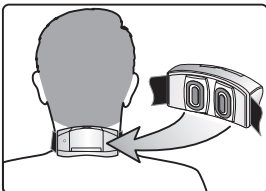

2. Fix the neck electrode unit to the posterior surface of the neck, making sure that both electrodes are in good contact with the skin.

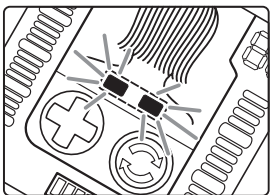





The control unit screen will display the indicators showing that the electrodes are in contact with the skin. If both electrodes are in good contact with the skin, both indicators light up. If either of the electrodes has poor contact with the skin, the indicator corresponding to this skin does not light up.

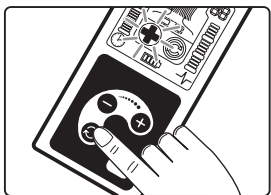

If neither of the electrodes is in contact with the skin surface for two minutes, the device shuts down.



3. Press the  button to select the Pain Therapy program. The  symbol will light up on the screen.

4. Set the required power level on the unit, using the  and  buttons on the control unit.



The program starts if the power level is set to a value higher than zero.

5. Perform the procedure.

The duration of this therapeutic program is twenty minutes. As soon as the therapeutic program is completed, the procedure will stop automatically.

Repeat the procedure as needed, if the patient has complaints.





The unit should be stored with dry electrodes.

6.2. — Program B (relaxation).

The program is used when the pain syndrome is absent or its intensity is not high and the patient has limited neck mobility, stiffness, extreme muscle tension in the shoulder girdle or the posterior surface of the neck.

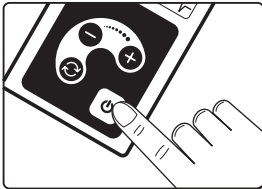
To perform the procedure:



1. Switch on the unit by pressing the  button on the control unit.

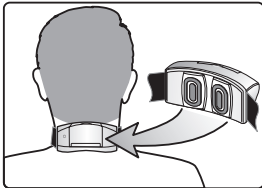

2. Fix the unit to the posterior surface of the neck, making sure that both electrodes are in good contact with the skin.

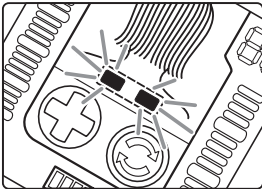





The control unit screen will display the indicators showing that the electrodes are in contact with the skin. If both electrodes are in good contact with the skin, both indicators light up. If either of the electrodes has poor contact with the skin, the indicator corresponding to this electrode does not light up.

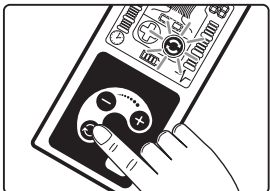

If neither of the electrodes is in contact with the skin surface for two minutes, the device shuts down.



3. Press the  button to select the Pain Therapy program. The  symbol will light up on the screen.

4. Set the required power level on the unit, using the  and  buttons on the control unit.



The program starts if the power level is set to a value higher than zero.

5. Perform the procedure.

The duration of this therapeutic program is fifteen minutes. As soon as the therapeutic program is completed, the procedure stops automatically.



The unit should be stored with dry electrodes.



WARRANTY MAINTENANCE FORM

EN

Name: DiaDENS-Osteo

Serial number of device _____

Manufacturing date _____

Date of purchase _____

Owner _____

Address: _____

Telephone _____ home

_____ work

Date device sent for maintenance _____

Please explain the reason why device was sent for
maintenance _____

Note of completed maintenance _____

Signature of the authorized person
in the company (organization)
responsible for acceptance after
maintenance _____

The device was tested; I have no claims as to the completeness of the device in accordance with scope of delivery and the appearance of the device.

Signature of the buyer _____

Date received _____

The warranty period for the device after maintenance is 6 months of the date the device was received from the service centre. If the warranty period is more than 6 months of the date of purchase of the device, the warranty period shall be calculated based on a longer period. The period of maintenance of the device at the maintenance centre is also added to the warranty period.

ACCEPTANCE CERTIFICATE

The DiaDENS-Osteo electrostimulation unit with integrated electrodes designed for stimulation of biologically active points and zones has been found serviceable.

Acceptance note:

Date of sale: _____

Signature of the seller: _____

I am aware of the warranty terms and conditions; the device was tested; I have no claims as to the completeness of the device in accordance with scope of delivery and the appearance of the device.

Signature of the buyer _____

*Please carefully inspect the unit at the time of purchase!
Defects of the body or the screen (scratches, cracks, splits) are not covered by the warranty. Devices with such defects shall not be exchanged, accepted for maintenance or returned.*